

# POWER METER

HC 6010

## Introduction

### About Power Meter HC 6010

HC 6010 power meters are conceptualized and intelligent to revolutionize the approach to traditional power metering.

Each power meter is a compact, electronically advanced and programmable multi-display metering device (MDMD). It is the answer to future generation of electrical metering needs and methodology.

### Environmental Impact & Cost Saving

A power meter can replace many units of conventional analog or digital instruments and change over switches (e.g. Amp, Volt, KVA, KW, PF, KWH, KVarH, FQ etc.).

This saves on the wiring material usage and reduces the cost on metering needs.

With the power meter modern and practical MDMD, the front layout of switch boards and control panels are aesthetically refined.

### Increase Productivity & Efficiency

The power meters are specifically designed to be compatible with the world's 2 most widely used DIN standard panel instruments (It fits the DIN 92 x 92 mm panel cutout holes).

The power meter as a MDMD greatly reduced cabling complexity and time. It is also a standardize hardware suitable for either 1 phase 2 wires, 1 phase 3 wires, 3 phase 3 wire or 3 phase 4 wires networks.

### Improved Technical Superiority and Reliability

The power meters are endowed with technical specifications, (overload capabilities, accuracy levels, long term stability, readout dependability etc.) far exceeding those of conventional instruments. To overcome the critiques of digital metering, the power meter MDMD supports a VFD (Vacuum Fluorescent Display) screen with green (naturally comfortable) alphanumeric readouts. This allows visual clarity at long distance yet avoids parallax errors for close range viewing. The multi-display readings can be "damped" through it readout resolution besides the option to manually or automatically prioritize and

sequentially view the more than 30 electrical parameters.

To meet future metering environments, the power meter is equipped with a serial port (RS-485 or RS-232), to allow connection to an open architecture computerized network. Running on PC or data acquisition system and complying with Modbus® protocol. The software provides a simple yet practical solution to energy management in factories and plant, small industries, building services, etc.

### Parameters Conversion

The microprocessor-based power meter now provides compatibility with the modicon Modbus® system as a standard featured. From the VFD multi-display reading V, A, VA, W, Var, WH, etc. more than 30 power and energy parameters. Via the RS-485 Modbus® communications, including the instant maximum and minimum of all parameters, maximum demand control, time stamping, etc. more than 90 parameters can be achieved by remote monitoring system.

## Features

- Over 90 power and energy parameters
- For factory and building automation
- Modbus® RTU protocol
- Maximum 600V
- True RMS conversion
- Instant maximum and minimum
- VFD display clear and long-life
- Build in RTC (real time clock)
- Field programmable PT / CT ratio
- Accuracy up to 0.15%
- 4 isolated analog outputs to transducer function
- 4 pulse outputs based on KWH, KVarH, KVAH or AH
- Maximum demand control applicable
- Memory for all setup and energy data
- Comprehensive self test diagnostics
- Low input burden 0.1VA (5A / 120V)
- Wide power supply range for AC / DC
- Compact physical configuration
- Compatible for DIN & ANSI cut out
- 2KV RMS input / output / power isolation



**HSIANG CHENG ELECTRIC CORP.**

4F., No.11, Ln. 235, Baoqiao Rd., Xindian Dist., New Taipei City 231, Taiwan (R.O.C.)

TEL : 886-2-29175865~9 FAX : 886-2-29173946

E-mail : expo.sales@hc.com.tw

HSIANG CHENG

### Factory & Building Automation (FA & BA)

The power meter was developed for factory and building automation (FA & BA) applications, more all of power and energy parameters can easily apply to wide range of AC switch-gear or industrial power distribution system for metering.

### PLC Modbus® Compatible

The Modbus® communications protocol allows information and data to be efficiently transferred between HC 6010 and modicon programmable logic controller (PLC) or other third party Modbus® compatible monitoring and control system. The HC 6010 can also establish a monitoring system just simply adopt an IPC-based centralized master display software. The RTU mode Modbus® protocol with default baud rate 9600 bps, 8 data bit.

### Build-in Real Time Clock (RTC)

HC 6010 power meters are with a build-in RTC (real time clock) that provide the internal time standard and time stamp for all records attached to each maximum and minimum energy measurements. RTC also provided the demand-control time period 15 / 30 minutes for maximum power demand control of utility load shedding.

### Memory for all setup and energy data

All of the meter status setting and energy data are retaining in memory while was lost power. HC 6010 power meter records includes the watt-hour that been measured, the record of maximum demand value, date and time, PT and CT ratio, the measured system configuration, displaying setting, and communication related.

### Field Programmability

The field programmable power meter is able to set e.g. CT and PT ratio, Modbus® address, communication baud rate, parity, meter's display, etc. either programming by push-bottom or by rear RS-485 / RS-232 communication port from a PC.

### Accuracy up to 0.15%

With a well developed conversion, sampling and software compensation technology that make HC 6010 power meter successfully meet the accuracy requirement of modern metering, that voltage and current up to 0.15% and other power up to 0.25%.

### Comprehensive System Integration

The HC 6010 power meter now provides the Modbus® (are compatible with the Modicon system as a standard feature for comprehensive system integration. The PLC compatible RS-485 / RS-232 Modbus® communication protocol allows information and data to be efficiently transferred between bower meter HC 6010 and Modicon programmable logic controller (PLC) existing RTU Power SCADA system and DCS system or other Modbus® protocol compatible system. For more detail information or software backup please contact Hsiang Cheng Electric Corp. or representative sales department.



## Model & Ordering Number

Model : HC 6010

Ordering : **HC 6010 — B — 5.0A — H — 1 — N**

Version

Current Input

1.0A

5.0A

7.5A

Power

H : AC 80-260V, DC 80-330V

L : DC 20-60V

Option

N : No option

A : Pulse output x 4

B : Analog output x 4

C : Pulse output x 2 + Analog output x 2

D : Pulse output x 1 + Analog output x 3

Y : Special ordering

Communication Part

1 : RS-485

2 : RS-232

3 : RS-485 + RS-232

4 : RS-485 x 2

Y : Special ordering

## Specification

### Programmable measurements / Accuracy / Display readouts

Parameter	Digital	Display (maximum)	Accuracy	Phase1	Phase2	Phase3	Total	Average
V x 3	5 (or 4)	9.9.9.9.9. V / KV	0.15% fs	V1	V2	V3		VE
A x 3	5 (or 4)	9.9.9.9.9. A / KA	0.15% fs	A1	A2	A3		AE
Watts	5 (or 4)	9.9.9.9.9. W / KW / MW / GW	0.25% fs	W1	W2	W3	W	
Vars	5 (or 4)	9.9.9.9.9. Var / KVar / MVar / GVar	0.25% fs	Var1	Var2	Var3	Var	
VA	5 (or 4)	9.9.9.9.9. VA / KVA / MVA / GVA	0.25% fs	VA1	VA2	VA3	VAE	
PF	4	0.9999	0.25% fs	PF1	PF2	PF3	PF	
WH	8	9.9.9.9.9.9.9. WH / KWH / MWH	0.8% rd				WH	
VarH	8	9.9.9.9.9.9.9. VarH / KVarH / MVarH	1% rd				VarH	
A0	5 (or 4)	9.9.9.9.9. A / KA	0.5% fs					
Hz	5 (or 4)	70.000	0.03% rd					

- Accuracy : Corresponding to each auto-range scale
- VL1 / VL2 / VL3 : Line to line voltage  
VP1 / VP2 / VP3 : Line to neutral voltage
- PF1 / PF2 / PF3 : Related conversion elements
- A0 (neutral current, only for 3 phase 4 wires)

- Accuracy performance range for WH / VarH / PF  
Cos  $\theta$  : 1-0.5 for WH / PF  
Sin  $\theta$  : 1-0.5 for VarH  
Voltage  $\geq$  75V, Current  $\geq$  10% of rate
- Phase rotation  
SEQ POST : positive sequence  
SEQ NEG : negative sequence



### HSIANG CHENG ELECTRIC CORP.

4F., No.11, Ln. 235, Baoqiao Rd., Xindian Dist., New Taipei City 231, Taiwan (R.O.C.)

TEL : 886-2-29175865~9 FAX : 886-2-29173946

E-mail : expo.sales@hc.com.tw

**Input**

- ⊙ Range
  - Voltage : 10 - 600V
  - Current : suitable for CT secondary rating (option)
    - Maximum 6A for 5A rating
    - Maximum 1.2A for 1A rating
  - Frequency : 40-70 Hz
- ⊙ Burden
  - Voltage < 0.4VA at 600V
  - < 0.04VA at 150V
  - Current < 0.1VA at rating
- ⊙ Overload rating
 

Current	Voltage
2 x rated continuous	750V continuous
10 x rated 30 seconds	1000V 10 seconds
25 x rated 2 seconds	1200V 3 seconds
50 x rated 1 second	

**Measured system**

- ⊙ Suitable for 3 phase 4 wires / 3 phase 3 wires / single phase 2 & 3 wires / 3 phase balance
- ⊙ Select by input wiring & software configuration

**Programmability**

- ⊙ Software accessible / password lock
- ⊙ System selection : 3 phase 4 wires / 3 phase 3 wires / 1 phase 2 & 3 wires and 3 phase balance
- ⊙ PT : 1 - 5000.0 ; CT : 1 - 65535
- ⊙ Readout display control
  - 5 or 4 digits / auto scan or manual selection / scanning time
- ⊙ Maximum demand 1 - 60 min
- ⊙ Maximum and minimum of instant measurement
- ⊙ Communication
  - Baud rate 1200 / 2400 / 4800 / 9600 / 19200
  - Address setting 1 - 254
- ⊙ Calibration : software with password lock
- ⊙ Memory : all of energy date and status setting

**Communication port**

RS485 ; RS232  
 MODBUS® RTU protocol (two port maximum)

**Display**

VFD/0.28"/green color, 3 rows of 9 alphanumeric

**Pulse output (PO) ..... option**

- ⊙ 4 pulse outputs photo-isolated (max.)
- ⊙ Configurable Parameter, WH / VarH / VAH / AH
  - Unit, +1WH / +1QH / 1VAH / 0.01AH
- ⊙ Pulse width / 50% duty cycle

**Analog output (AO) ..... option**

- ⊙ 0.5% fs accuracy
- ⊙ 4 isolated analog outputs (maximum)
- ⊙ Standard output 4-20mAdc / load < 500 Ω
- ⊙ Configurable Measured parameters
  - Input range, unipolar / bipolar

**Event logger**

200 events with time-stamped  
 Status change of switch input  
 Activation of setpoints / alarms  
 Operation of controlled relay output  
 Failure in self-test  
 Programming access  
 Trace memory triggered  
 Power ON / OFF

**Maximum / minimum logger**

20 parameters with time-stamped VP1, VP2, VP3, VPe, VL1, VL2, VL3, VLe, A1, A2, A3, AO, Ae, W, Var, VA, F, PF, Vubl, Aubl

**RTC**

Maximum deviation 5 sec in 24 hours  
 Time for year / month / date / hour / minute / sec

**Dielectric strength**

IEC 255-5  
 2KV AC rms 1 minute between input/output/power

**Impulse and surge test**

ANSI/IEEE C37.90.1-1989 (3KV) SWC test  
 IEC 255-22-1 class III SWC test  
 IEC 255-22-4 class IV (IEC 801-4) SWC test  
 IEC 255-5 1.2 x 50us (5KV) impulse test

**HSIANG CHENG ELECTRIC CORP.**

4F., No.11, Ln. 235, Baoqiao Rd., Xindian Dist., New Taipei City 231, Taiwan (R.O.C.)

TEL : 886-2-29175865~9 FAX : 886-2-29173946

E-mail : expo.sales@hc.com.tw

### Stability

Temperature range  $-25$  to  $+55^{\circ}\text{C}$ ,  
maximum 100 ppm/  $^{\circ}\text{C}$   
Long term stability 0.15% drift maximum per year

### Operating condition

Temperature range  $-25$  to  $+60^{\circ}\text{C}$ , RH 20 - 95%  
non-condensed

### Storage condition

Temperature range  $-25$  to  $+70^{\circ}\text{C}$ , RH 20 - 95%  
non-condensed

### Power supply

- ⊙ AC 80 - 260V, 40 - 70 Hz, DC 80 - 330V  
DC 20 - 60V
- ⊙ Dissipation maximum 12VA for AC and 6W for DC

### Mounting / Dimension

Panel type mounting  
Size : 120 x 120 x 130.5 mm  
Cut out : 92 x 92 mm

## Dimension

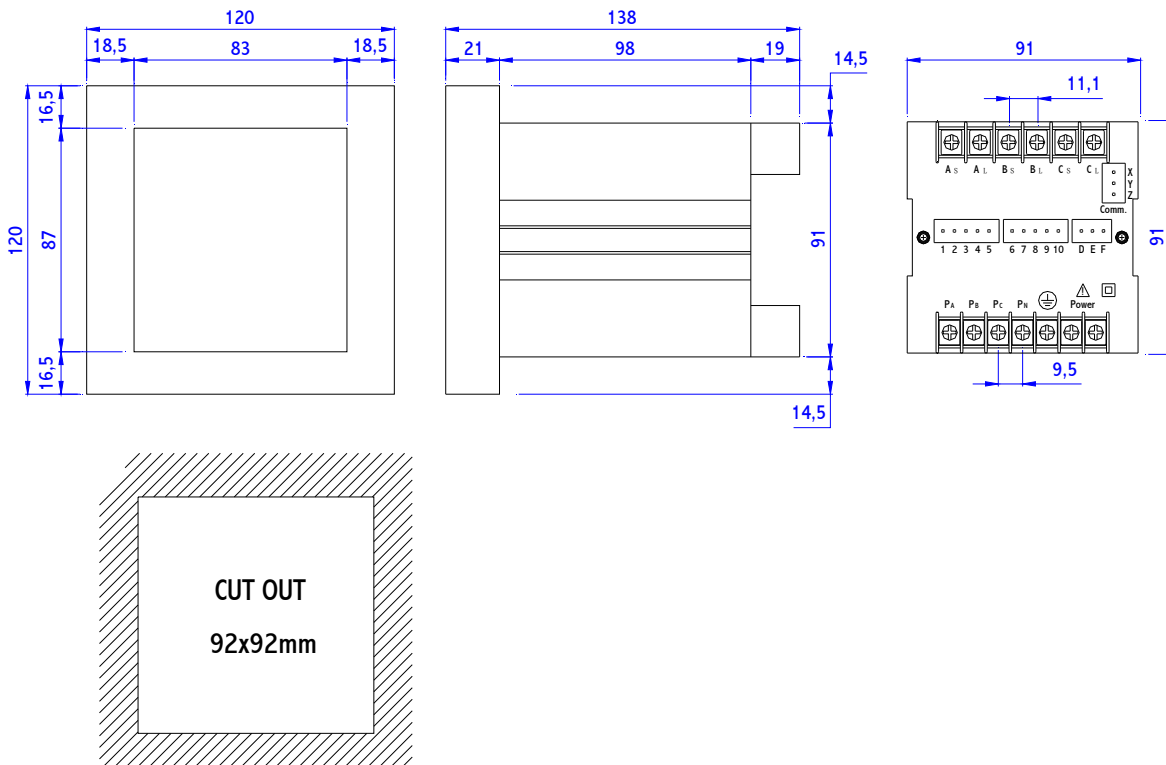

### Wiring

\* 3P3W (2CT)

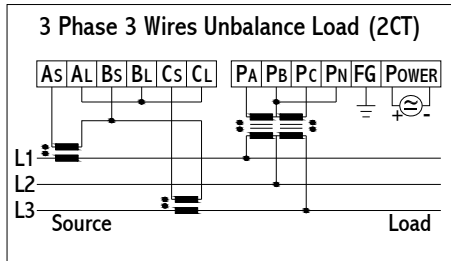

\* 3P4W2T

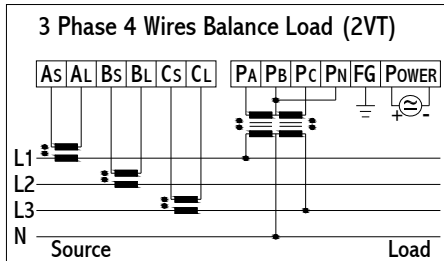

\* 3P3W (3CT)

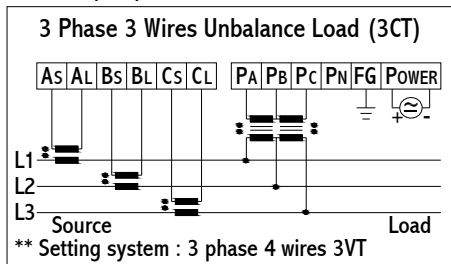

\* 3P4W3T

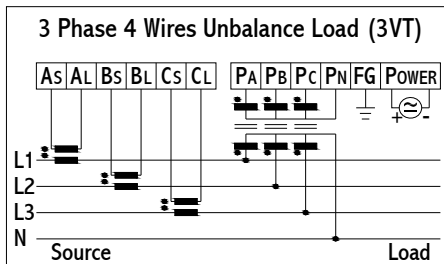

\* 1P2W

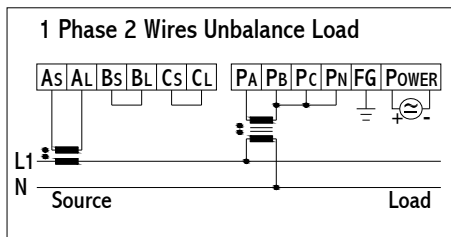

\* 1P3W

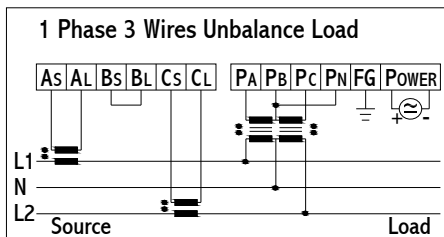

Note : \* for power system setting display code.

### Communication Port

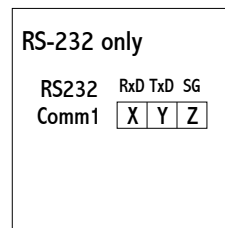
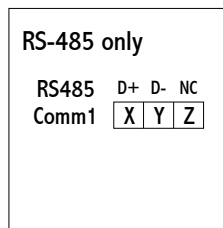
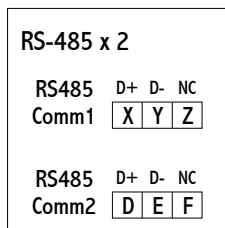
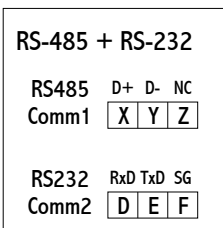

### Output Port

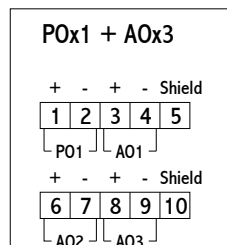
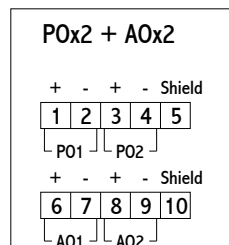
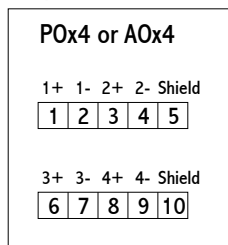

### Applications

The HC 6010 PC tool a utility program that can help user to connect to “HC 6010 Power Transducer” rapidly. The HC 6010 PC Tool is provided along with every HC 6010, which allows easy access to all meter setup information and actual values via a personal computer running Windows 95/98 and one of the PC's communication ports (COM1 or COM2). The PC Tool is able to do the function as bellows:

- Program / Modify setup information
- Load / save setup information files from / to disk
- Read actual “Basic” value (current / voltage / power / frequency)
- Read actual “statistics” value (maximum/minimum/time of maximum/time of minimum)
- Output control (Pulse output / Analog output)

The HC 6010 PC Tool can be used as stand-alone without a HC 6010 to create or edit HC 6010 setup information file.

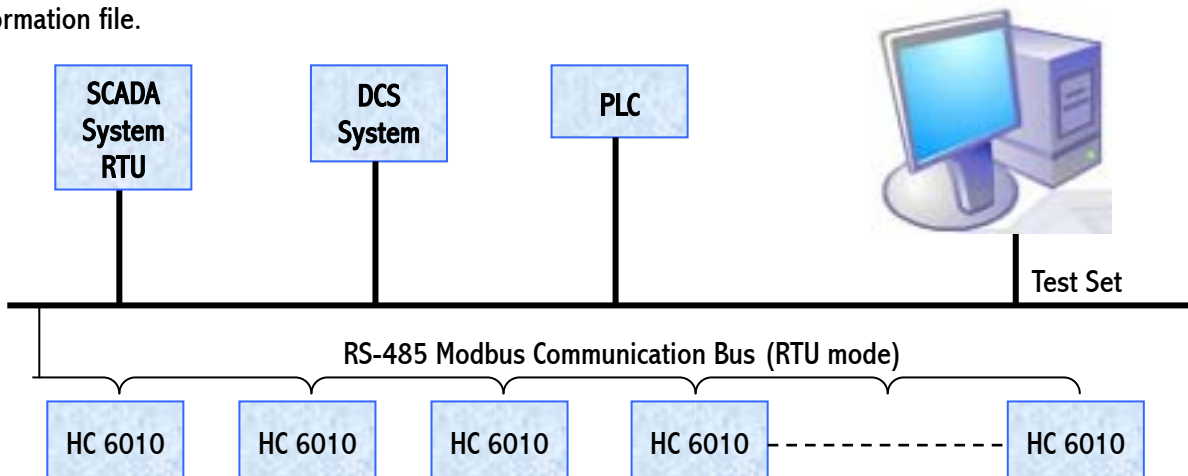

### Communication Wiring

